

CAPITOLO 7

MÜLLER Fissaggio



Chiavi



Chiave moderna

Ottone

L	Finitura	Codice
40	Oro	2105 671 140
40	Nichel satinato	2105 671 150

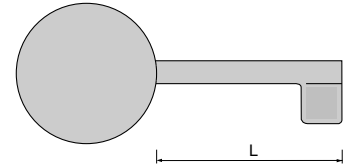

Chiave moderna

Ottone

L	Finitura	Codice
50	Oro	2105 209 150

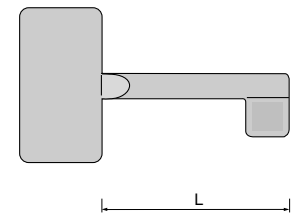

Chiave classica

Ottone

L	Finitura	Codice
30	Oro	2105 281 130
40	Oro	2105 281 140

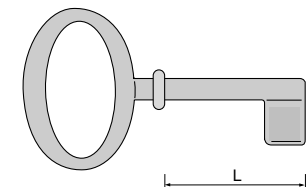

Chiave classica

Ottone

L	Finitura	Codice
35	Oro	2105 331 135
30	Oro	2105 331 180
45	Nichelata	2105 331 345
35	Bronzo antico	2105 332 135
40	Bronzo antico	2105 332 140
45	Bronzo antico	2105 332 145

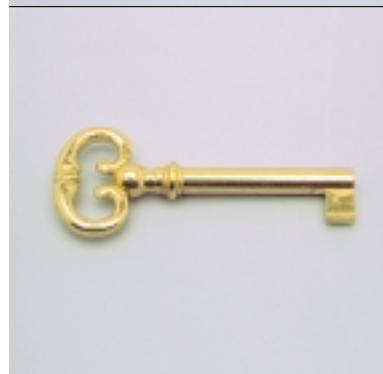
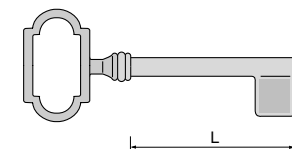

Chiave classica

Ottone

L	Finitura	Codice
35	Oro	2105 261 135
40	Oro	2105 261 140
45	Oro	2105 261 126

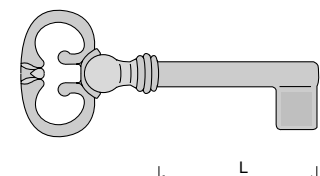

Chiavi e bocchette



Chiave in stile

Ottone

A x B > C	Finitura	Codice
24 x 52 > 24	Ottone anticato	1911 611 106
24 x 58 > 29	Ottone anticato	1911 611 105
24 x 69 > 42	Ottone anticato	1911 611 107
24 x 81 > 53	Ottone anticato	1911 611 108

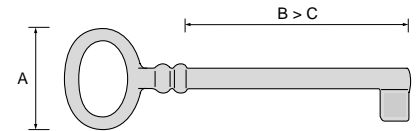

Chiave in stile

Ottone

A x B > C	Finitura	Codice
24 x 77 > 42	Ottone anticato	1911 660 907
29 x 88 > 53	Ottone anticato	1911 660 908

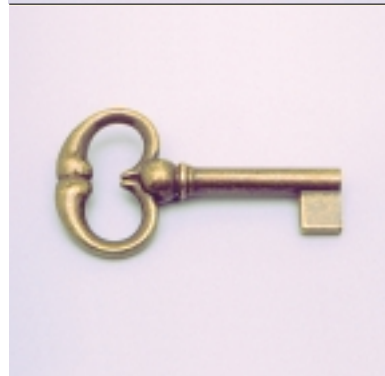
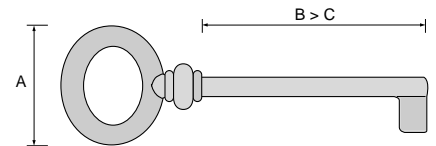

Chiave in stile

Ottone

L	Finitura	Codice
33	Bronzo antico	2105 301 430
42	Bronzo antico	2105 301 442

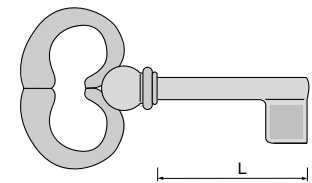

Bocchetta classica

Ottone

Mis.	Finitura	Codice
28x35	Oro	2106 321 100
28x35	Bronzo antico	2106 322 100

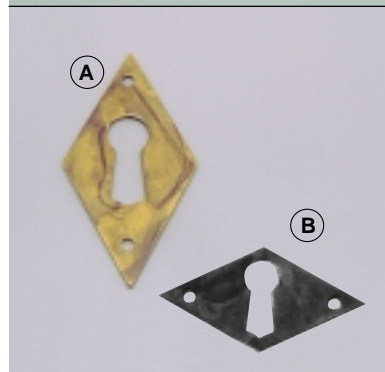
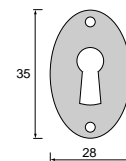

Bocchette in stile

Ottone

	Mis.	Finitura	Codice
A	25x49	Anticata	1911 458 405
B	49x25	Anticata	1911 467 705

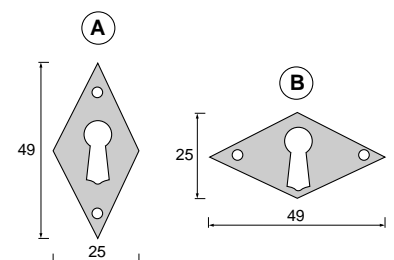

Pomoli

Pomolo classico

Ottone

∅	B	Finitura	Codice
20	20	Ott. lucido	2116 073 20L
20	20	Ott. nero perla	2116 073 20P
20	20	Cromato	-
25	25	Ott. lucido	2116 073 25L
25	25	Ott. nero perla	2116 073 25P
25	25	Cromato	-

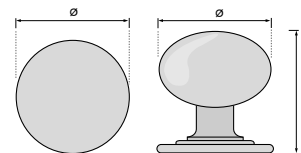

Pomolo classico

Ottone

∅	B	C	Finitura	Codice
20	17	17	Ott. lucido	2116 072 20L
20	17	17	Ott. nero perla	-
20	17	17	Cromato	2116 072 20C
25	20	18	Ott. lucido	2116 072 25L
25	20	18	Ott. nero perla	-
25	20	18	Cromato	2116 072 25C

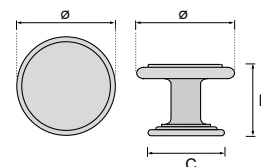

Pomolo classico

Ottone

∅	B	C	Finitura	Codice
20	18	17	Ott. lucido	2116 075 21L
20	18	17	Ott. nero perla	-
20	18	17	Cromato	-
25	21	18	Ott. lucido	2116 075 26L
25	21	18	Ott. nero perla	-
25	21	18	Cromato	-

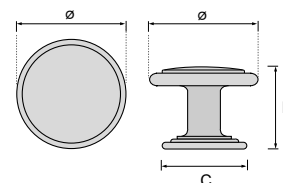

Pomolo classico

Ottone

∅	B	C	Finitura	Codice
20	23	20	Ott. lucido	2116 071 20L
20	23	20	Ott. nero perla	2116 071 20N
20	23	20	Cromato	2116 071 20C
25	30	25	Ott. lucido	2116 071 25L
25	30	25	Ott. nero perla	2116 071 25P
25	30	25	Cromato	2116 071 25C

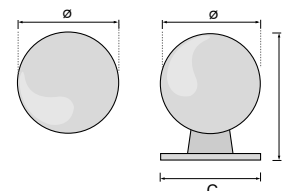

Pomolo in stile

Ottone

∅	H	Finitura	Codice
28	24	Anticata	1911 338 502

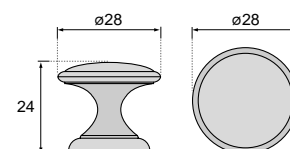

Pomoli



Pomolo in stile

Ottone

∅	H	Finitura	Codice
17	15	Anticata	1911 338 017
20	18	Anticata	1911 338 020
27	23	Anticata	1911 338 027
32	25	Anticata	1911 338 032
36	28	Anticata	1911 338 036

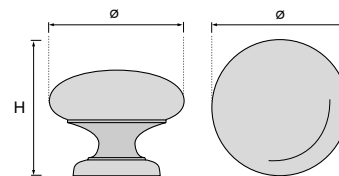

Pomolo in stile

Ottone

∅	H	Finitura	Codice
15	15	Anticata	1911 330 400
28	22	Anticata	1911 330 401

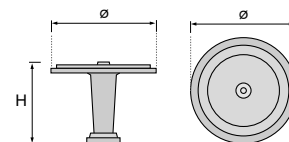

Pomolo in stile

Ottone

∅	H	Finitura	Codice
25	21	Anticata	1911 326 025
30	24	Anticata	1911 326 031
35	28	Anticata	1911 326 037

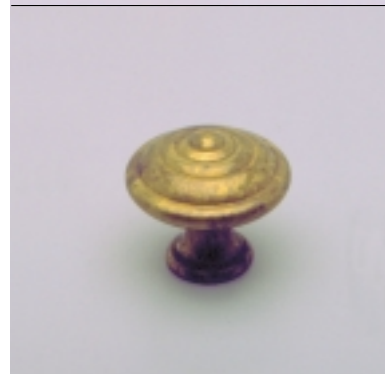
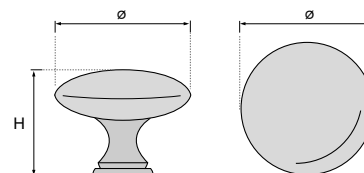

Pomolo in stile

Ottone

∅	H	Finitura	Codice
25	23	Anticata	1911 330 802
30	26	Anticata	1911 330 803
35	30	Anticata	1911 330 804

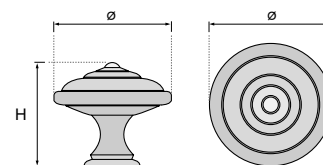

Pomolo in stile

Ottone

∅	H	Finitura	Codice
16	12	Anticata	1911 339 416
20	15	Anticata	1911 339 420
22	15	Anticata	1911 339 422
25	19	Anticata	1911 339 425
30	20	Anticata	1911 339 430

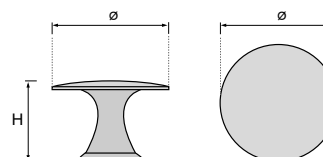

Pomoli



Pomolo

Metallo pressofuso
Impugnatura morbida

ø	H	Finitura	Codice
25	26	Bianca	2114 690 101
25	26	Nera	2114 690 201
25	26	Rossa	2114 690 601
25	26	Gialla	2114 690 701
25	26	Cromo lucido	2114 691 001
25	26	Oro lucido	2114 691 100

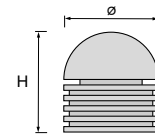

Pomolo

Ottone

ø	Finitura	Codice
12	Bianca	2114 980 100
12	Oro lucido	2114 980 101
12	Cromo lucido	2114 980 102
12	Nera	2114 980 200
12	Rossa	2114 980 600

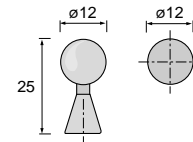

Pomolo

Ottone

ø	Finitura	Codice
20	Oro lucido	2114 350 101
20	Nera opaca	2114 350 102
20	Cromo lucido	2114 350 104
25	Oro lucido	2114 350 100
25	Nera opaca	2114 350 103
25	Cromo lucido	2114 350 105

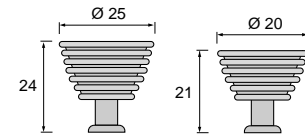

Pomolo

Impugnatura in metallo pressofuso
Base in plastica nera

ø	H	Finitura	Codice
14	20	Nera	2112 000 020
23	30	Nera	2112 000 021
31	38	Nera	2112 000 022

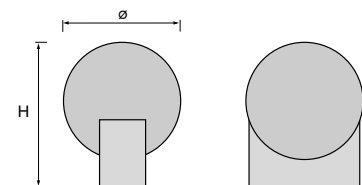

Pomolo

Pressofuso

Mis.	Finitura	Codice
40x22	Nera opaca	2114 070 100
40x22	Dorata	2114 070 101
40x22	Cromo satinato	2114 070 102
40x22	Cromo lucido	2114 070 103

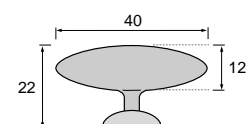

Pomoli



Pomoli in legno

	ø 26	ø 30	ø 35	ø 40
Finitura	Codice			
Pino grezzo	2125 773 026	2125 773 030	2125 773 035	2125 773 040
Frassino GR	2125 773 226	2125 773 230	2125 773 235	2125 773 240
Laccata bianca	2125 770 026	2125 770 030	2125 770 135	2125 770 040

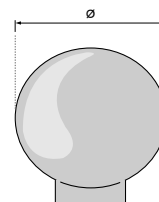

Pomoli in legno

ø	Finitura	Codice
30	Pino grezzo	2125 513 030
35	Pino grezzo	2125 513 035
40	Pino grezzo	2125 513 040

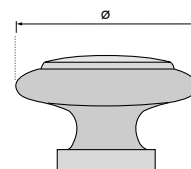

Pomoli in legno

	ø 26	ø 30	ø 35	ø 40
Finitura	Codice			
Faggio grezzo	2125 703 126	2125 703 130	2125 703 135	2125 703 140
Noce grezzo	2125 704 026	2125 704 030	2125 704 035	2125 704 040

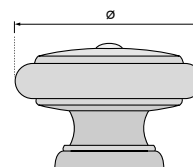

Pomoli in legno

ø	Finitura	Codice
26	Pino grezzo	2125 713 026
30	Pino grezzo	2125 713 030
35	Pino grezzo	2125 713 035
40	Pino grezzo	2125 713 040

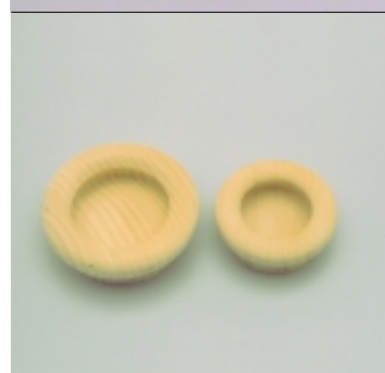
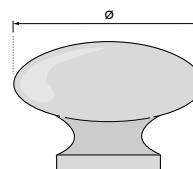

Maniglia ad incastro

ø	Finitura	Codice
40	Frassino grezzo	2125 803 240
50	Frassino grezzo	2125 803 250

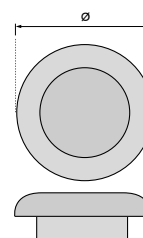

Pomoli

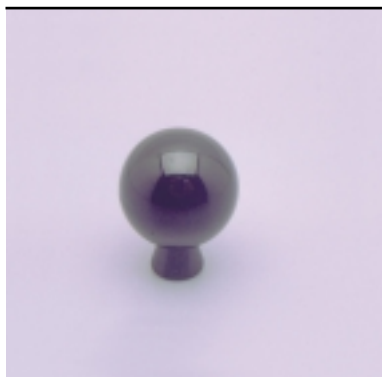

Pomolo in metallo

Pressofusione di lega leggera, verniciato con polveri epossidiche.

	∅ 15 - H 18,5	∅ 20 - H 25	∅ 25 - H 31	∅ 30 - H 35
Finitura	Codice			
Bianca	2112 005 014	2112 005 013	2112 005 012	2112 005 015
Nera	2112 005 024	2112 005 023	2112 005 022	2112 005 025
Rossa	2112 005 064	2112 005 063	2112 005 062	2112 005 061
Gialla	2112 005 074	2112 005 073	2112 005 072	2112 005 075
Verde	2112 005 090	2112 005 091	2112 005 092	2112 005 093

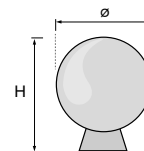

Pomolo in metallo

Pressofusione di lega leggera, verniciato con polveri epossidiche.

∅	Finitura	Codice
20	Bianca	2112 074 0BI
20	Nera	2112 078 0NE
20	Marrone	2112 077 0MA
20	Frassino	2112 075 0FR
20	Rossa	2112 079 0RO
20	Gialla	2112 076 0GI

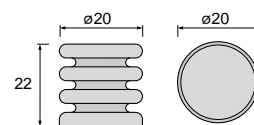

Pomolo in porcellana

In porcellana e ottone

∅	Finitura	Codice
27	Bianca	2116 097 25D

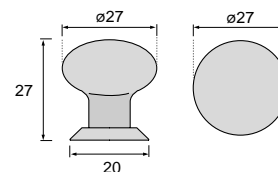

Pomolo in porcellana

In porcellana e ottone

∅	Finitura	Codice
27	Bianca	2116 098 25B

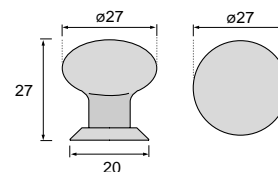

Maniglie

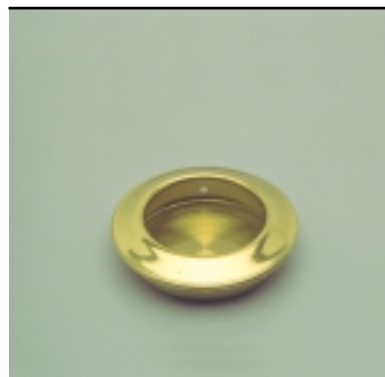

Maniglia ad incasso

A bordo sagomato in ottone

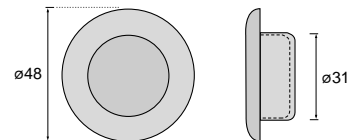

ø	Finitura	Codice
48	Ottone	2131 G01 051
48	Nichelata	2131 G01 048



Maniglia ad incasso

Ottone

	Mis. 30	Mis. 40	Mis. 50
Finitura	Codice		
Oro lucido	2131 951 130	2131 951 140	2131 951 150
Oro satin.	2131 952 030	2131 952 040	-
Nichelata	2131 951 330	2131 951 340	2131 951 350
Nichelata satin.	2131 951 930	2131 951 940	-
Nichelata nero	-	2131 951 840	-
Cromo	2131 951 030	2131 951 040	2131 951 050

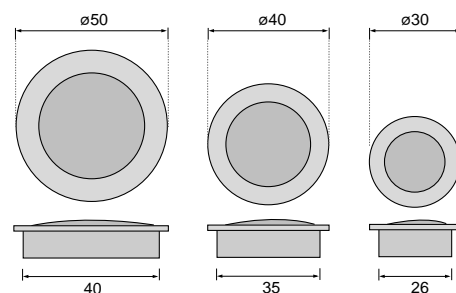

Maniglie ad incasso

Ottone

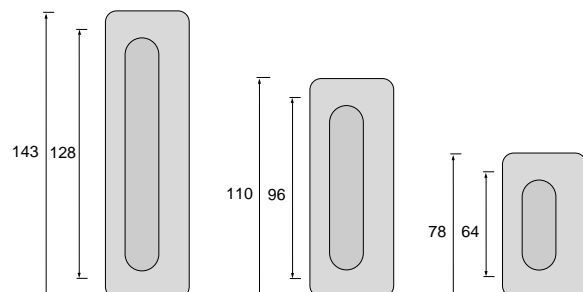

Interasse	Mis. 64	Mis. 96	Mis. 128
Finitura	Codice		
Oro lucido	2131 981 164	2131 981 196	2131 981 199
Oro satinato	2131 982 064	2131 982 096	2131 982 099
Nichelata	2131 981 864	2131 981 396	-
Nichelata nera	-	2131 981 896	2131 981 899

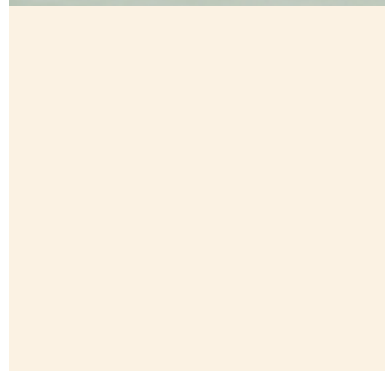

Maniglia ad incasso

Ottone

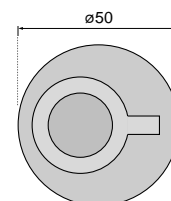

ø	Finitura	Codice
50	Oro satinato	2131 802 000
50	Oro lucido	2131 802 001



Maniglie

Maniglie ad incasso

in ottone



Bordo quadro con fori

AxB	Finitura	Codice
50X38	Oro lucido	2131 871 150
50X38	Oro satinato	2131 872 150
50X38	Oro lucido	2131 871 151
50X38	Oro satinato	2131 872 151

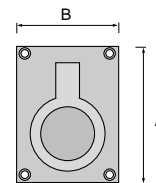

Bordo tondo senza fori

AxB	Finitura	Codice
40x30	Oro lucido	2131 BA1 140
40x30	Nichelato	
40x30	Nichel nero	2131 BA1 240
50x38	Oro lucido	2131 BA1 150
50x38	Nichelato	2131 BA1 350
50x38	Nichel nero	
60x47	Oro lucido	
60x47	Nichelato	2131 BA1 360
60x47	Nichel nero	

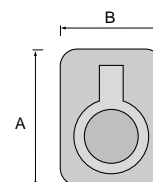

Maniglia ad incasso



Mis.	Finitura	Codice
85x55	Ottone lucido	2131 G01 054
85x55	Nichelato	2131 G01 054

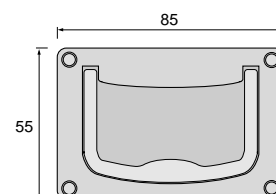

Maniglie



Maniglia

Metallo pressofuso - diametro fisso mm 8

Tipo	Finitura	Codice
A	Bianca	2129 601 001
A	Nera	2129 601 007
A	Oro lucido	2129 601 004
A	Cromato	2129 601 010
B	Bianca	2129 601 002
B	Nera	2129 601 008
B	Oro lucido	2129 601 005
B	Cromato	2129 601 011
C	Bianca	2129 601 003
C	Nera	2129 601 009
C	Oro lucido	2129 601 006
C	Cromato	2129 601 012

(A)

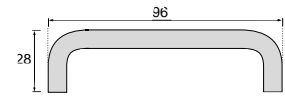

(B)

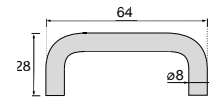

(C)

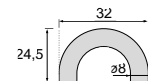

Maniglia

Metallo pressofuso
Tipo A diametro 10 mm
Tipo B diametro 8 mm

Tipo	Finitura	Codice
A	Oro lucido	
A	Cromo lucido	2114 630 101
A	Nichel satinato	2114 630 100
B	Oro lucido	
B	Cromo lucido	2114 630 102
B	Nichel satinato	2114 630 103

(A)

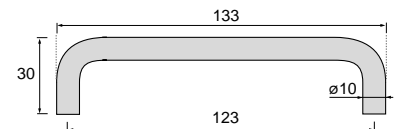

(B)

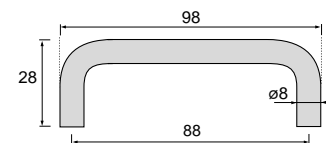

Maniglia

Metallo pressofuso
Tipo A diametro 10 mm
Tipo B diametro 8 mm

Tipo	Finitura	Codice
A	Oro lucido	2114 690 104
A	Cromo lucido	2114 690 105
A	Nichel satinato	
B	Oro lucido	2114 690 106
B	Cromo lucido	2114 690 107
B	Nichel satinato	

(A)

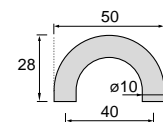

(B)

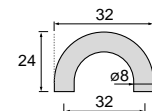

Maniglia

Metallo pressofuso

L	Codice
160	
224	
320	
384	
500	2114 710 100

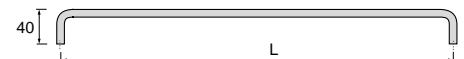

Maniglie



Maniglia moderna

Metallo pressofuso

	L192	L128	L96
Finitura	Codice		
Nic. sat.	2128 960 100	2128 960 104	2128 960 108
Cr. luc.	2128 960 101	2128 960 105	2128 960 109
Dora.	2128 960 102	2128 960 106	2128 960 110
Nero op.	2128 960 103	2128 960 107	2128 960 111
Bianca	2128 960 113	2128 960 114	2128 960 112

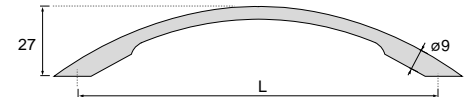

Maniglia moderna

Metallo pressofuso

Mis.	Finitura	Codice
A	Dorata	2128 890 102
B	Dorata	2128 890 100

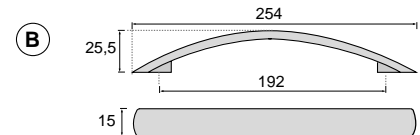
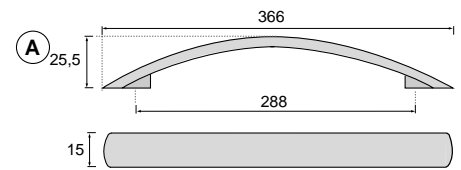

Maniglia moderna

Metallo pressofuso

Mis.	Finitura	Codice
A	Dorata	2129 905 030
A	Cromata	2129 905 032
B	Dorata	2129 905 033
B	Cromata	2129 905 034
C	Dorata	2129 905 035
C	Cromata	2129 905 036

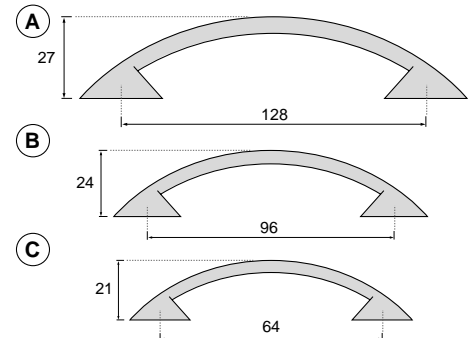

Maniglia moderna

Metallo pressofuso

Mis.	Finitura	Codice
A	Dorata	2128 940 100
A	Cromata	2128 940 101
B	Dorata	2128 940 102
B	Cromata	2128 940 103

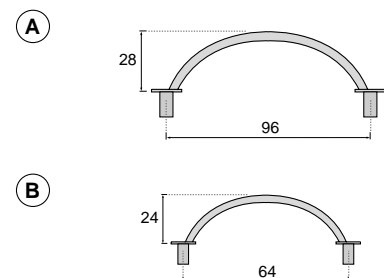

Maniglia moderna

Metallo pressofuso

Mis.	Finitura	Codice
A	Nichelata sat.	2128 945 100
A	Dorata	2128 945 101
A	Bronzo	2128 945 102
A	Nera opaca	2128 945 103
B	Nichelata sat.	2128 945 104
B	Dorata	2128 945 105
B	Bronzo	2128 945 106
B	Nera opaca	2128 945 107

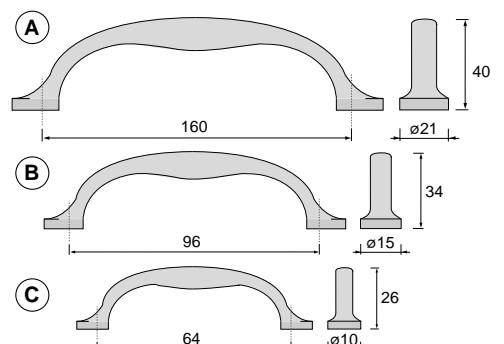

A richiesta misura C

Maniglie



Maniglia

Metallo pressofuso

Mis.	Finitura	Codice
A	Bianca	2128 300 200
A	Nera	2128 300 201
B	Nera	2128 300 202
B	Bianca	2128 300 203
C	Nera	2128 300 204
C	Bianca	2128 300 205

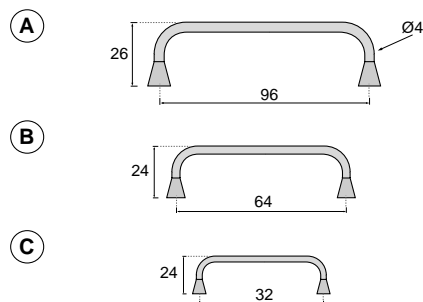

Maniglia

Acciaio Inox

L	Inox lucido	Inox satinato
500		
384	2128 940 107	2128 940 105
224	2128 890 108	2128 940 106
160		

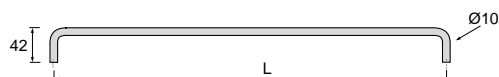

Maniglia

Acciaio Inox

L	L1	Finitura	Codice
448	517	Inox	2128 890 095
320	387	Inox	2128 890 096
224	292	Inox	2128 890 097
128	196	Inox	2128 890 099

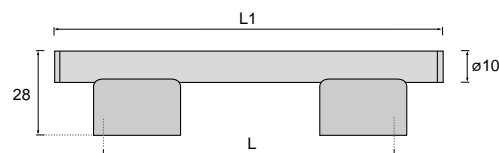

Maniglia

Metallo pressofuso

Mis.	Finitura	Codice
96X28	Oro satinato	2129 886 001
96X28	Nichelata sat	2129 886 002

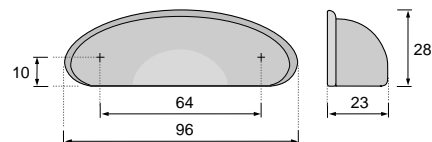

Maniglie



Maniglia in stile

Ottone

Mis.	Finitura	Codice
75x38	Oro	1913 A79 100

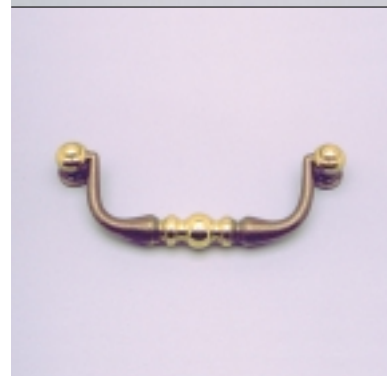
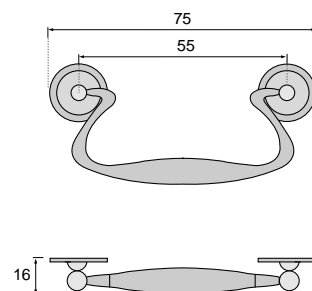

Maniglia in stile

Metallo pressofuso

Mis.	Finitura	Codice
116x46	Anticata	1911 109 125

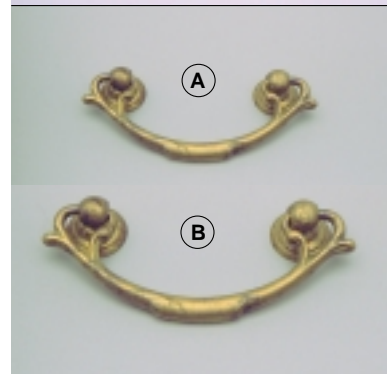
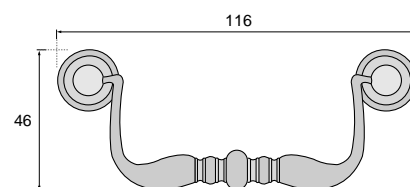

Maniglie in stile

Metallo pressofuso

	Mis.	Finitura	Codice
A	89x41	Bronzo antico	1911 132 308
B	124x51	Bronzo antico	1911 132 312

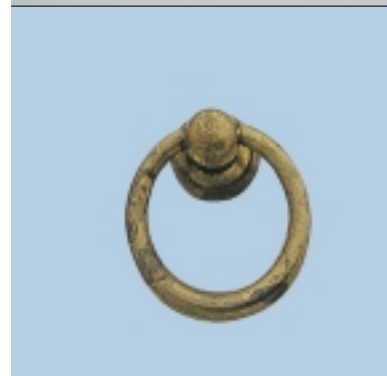
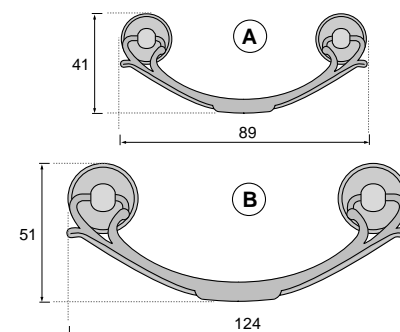

Maniglie in stile

Metallo pressofuso

Mis.	Finitura	Codice
23x28	Anticata	
33x39	Anticata	1911 109 122
40x44	Anticata	
50x57	Anticata	

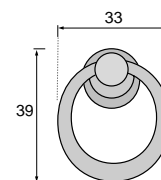

Maniglie - Pomoli - Battente per porte



Pomolo per porte
Ottone

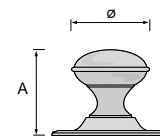

A	Ø	Codice
68	60	
70	70	2120 691 170
75	90	2120 691 190



Battente per porte
Ottone

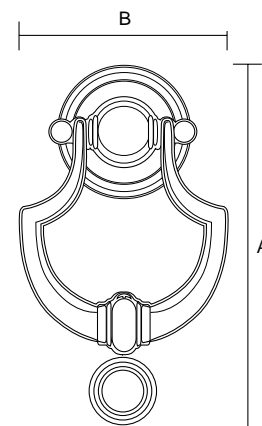

A	B	Codice
130	100	
158	125	2120 700 110
191	150	2120 700 112

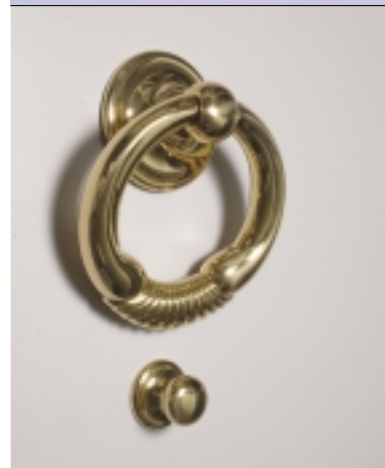

Battente per porte
Ottone

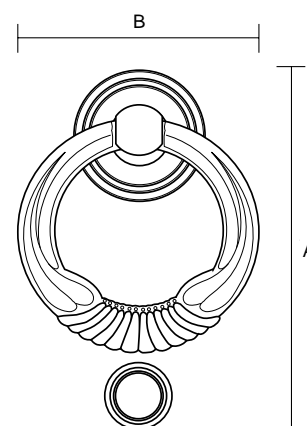

A	B	Codice
128	100	
153	125	2120 700 153
192	150	2120 700 150

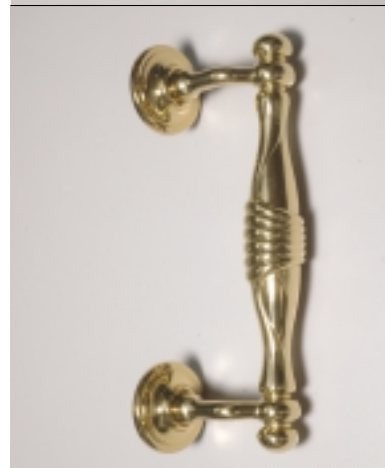

Maniglioni per porte
Ottone

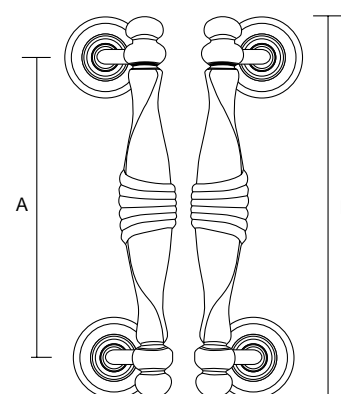

A	B	Codice
235	244	2135 529 010
400	460	2135 529 011

Maniglie - Pomelli - Pendenti



Pomello serie ECO

Zama
Ottonato rotobarile

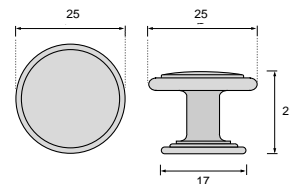

Ø	Codice
25	1900 042 025



Pomello serie ECO

Zama
Ottonato rotobarile

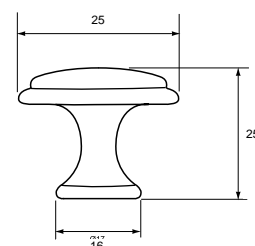

Ø	Codice
25	8001 010 200



Pendente serie ECO

Zama
Ottonato rotobarile

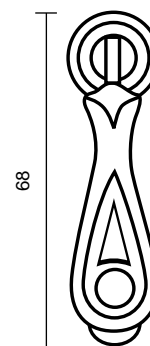

Misura	Codice
68	8001 010 200



Maniglia serie ECO

Zama
Ottonato rotobarile

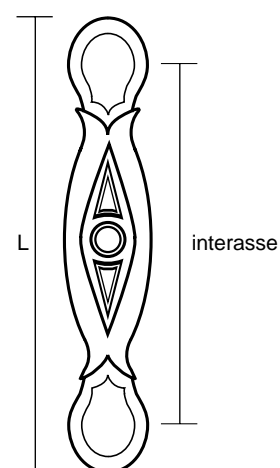

L	Interasse	Codice
82	64	8001 010 210
115	96	8001 010 220

