

CAPITOLO 6

MÜLLER Fissaggio



Guide per cassetti



Guida per cassetto

Acciaio verniciato
 montaggio sotto il cassetto con stabilità laterale
 chiusura automatica negli ultimi 60 mm
 portata Kg. 30

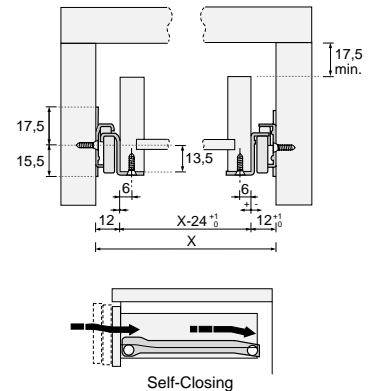
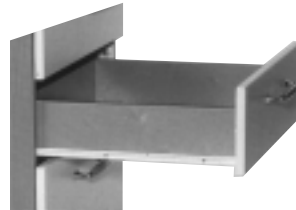

L	Codice			
	Bianche	Nere	Marroni	All. Ral. 9006
250	3008 020 250	3008 030 250	3008 040 250	3008 010 250
275	3008 020 275	3008 030 275	3008 040 275	3008 010 275
300	3008 020 300	3008 030 300	3008 040 300	3008 010 300
350	3008 020 350	3008 030 350	3008 040 350	3008 010 350
400	3008 020 400	3008 030 400	3008 040 400	3008 010 400
450	3008 020 450	3008 030 450	3008 040 450	3008 010 450
500	3008 020 500	3008 030 500	3008 040 500	3008 010 500
550	3008 020 550	3008 030 550	3008 040 550	3008 010 550
600	3008 020 600	3008 030 600	3008 040 600	3008 010 600

Fissaggio guida sul fianco

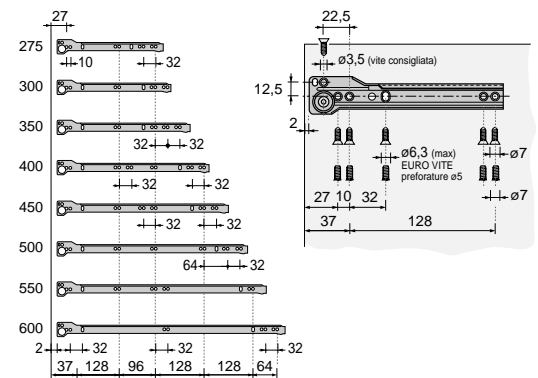

Guida per piani estraibili

Acciaio verniciato
 montaggio sotto il pianetto con stabilità laterale
 chiusura automatica negli ultimi 40 mm
 portata Kg. 25

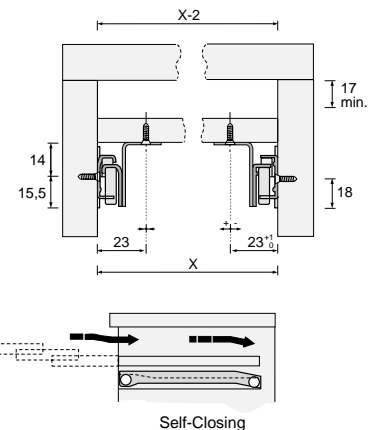
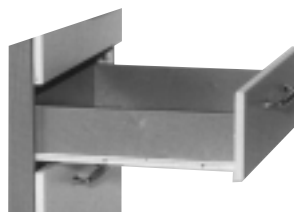

Fissaggio guida sul fianco

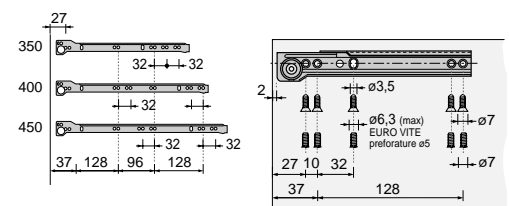

L	Codice	
	Bianco	Nero
350	3006 005 035	3006 006 035
400	3006 005 040	3006 006 040
450	3006 005 045	3006 006 045

Guide per cassette senza fianchi



Guida per piani o cassette senza fianchi

Acciaio verniciato
 montaggio sotto il piano anziché sui fianchi
 portata Kg. 30

la sicura di bloccaggio impedisce lo sganciamento accidentale del cassetto o del piano
 la guida ideale per un montaggio successivo di cassette su piani di lavoro esistenti

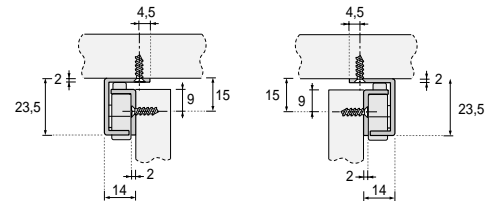

L	Codice	
	Bianco	
300	3003 023 300	
350	3003 023 350	
400	3003 023 400	
450	3003 023 450	
500	3003 023 500	
550	3003 023 550	
600	3003 023 600	

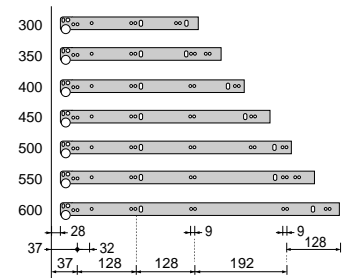

Guide per cassette tipo clamp

Acciaio verniciato
 Montaggio sotto il cassetto a pressione
 Chiusura automatica negli ultimi 60 mm
 Portata 30 kg

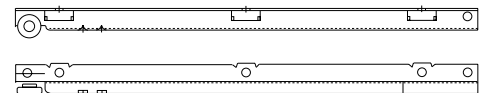

L	Codice	
	Bianco	Marrone
300	3001 500 300	3001 600 300
350	3001 500 350	3001 600 350
400	3001 500 400	3001 600 400
450	3001 500 450	3001 600 450
500	3001 500 500	3001 600 500
550	3001 500 550	3001 600 550
600	3001 500 600	3001 600 600

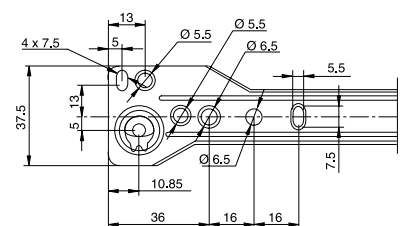

Guide per cassette

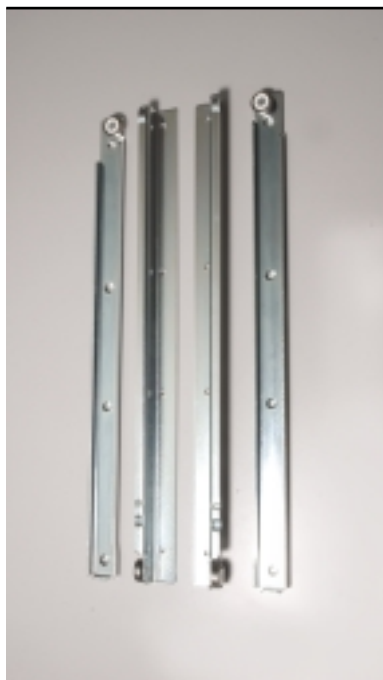

Guide su rotelle

Portata max 100 Kg

15 lunghezze binario da 300-1000 mm
 finitura zincata
 portata max 100 Kg
 per montaggio sul fondo e carichi elevati
 doppio fermo, sicura antiscivolo e fermo di ritorno
 incorporati
 cuscinetti a sfere con anelli di scorrimento in
 acciaio e pattini laterali in plastica

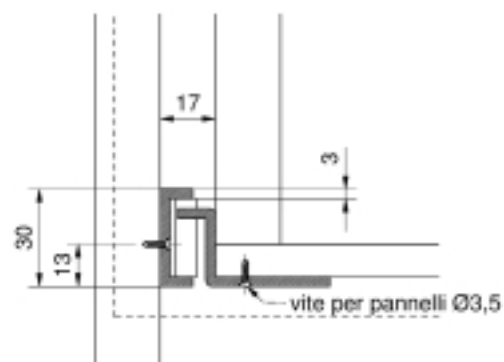

L	P	PE	Codice
300	305	57	2511 05F R30
350	355	57	2511 05F R35
400	405	74	2511 05F R40
450	455	74	2511 05F R45
500	505	74	2511 05F R50
550	555	74	2511 05F R55
600	605	84	2511 05F R60
650	655	84	2511 05F R65
700	705	84	2511 05F R70
750	755	104	2511 05F R75
800	805	104	2511 05F R80
850	855	104	2511 05F R85
900	905	104	2511 05F R90
950	955	104	2511 05F R95
1000	1005	104	2511 05F R99

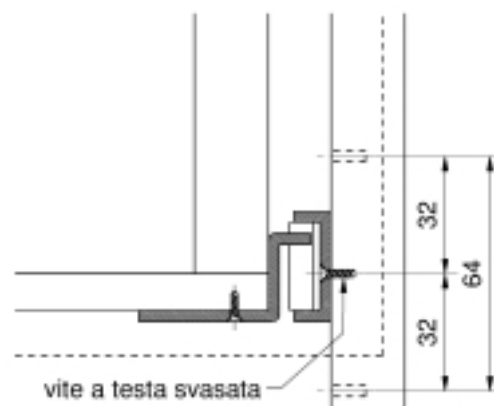

Guida per cassette a doppia estrazione

Acciaio verniciato
 montaggio sotto il cassetto con stabilità laterale
 chiusura automatica negli ultimi 40 mm
 portata Kg. 30

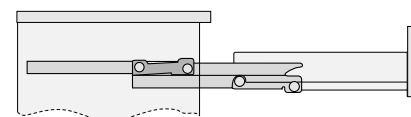
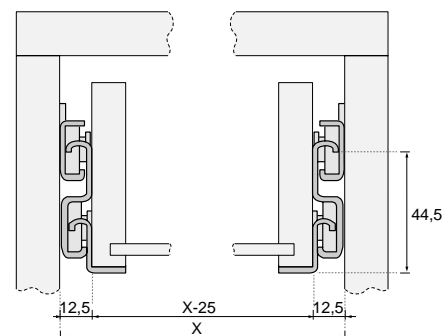

L	Codice
	Bianco
300	3008 090 300
350	3008 090 350
400	3008 090 400
450	3008 090 450
500	3008 090 500
550	3008 090 550
600	3008 090 600

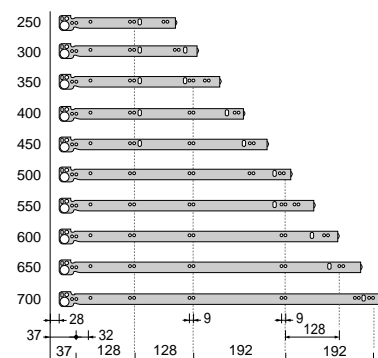

Guide per cassette



Guida quadro per cassette Estrazione semplice

Acciaio
sistema di scorrimento su sfere
montaggio rapido a innesto
meccanismo completamente nascosto
portata max. 25 Kg
per cassette con spondine di legno

C = INTERASSE (aggancio - regolazione)
KS = INTERASSE FORI GUIDA
P = PROFONDITÀ MINIMA MOBILE
PE = PERDITA ESTRAZIONE

L	C	KS	P	PE	Codice
300	118.5	160	313	50	3060 211 130
350	221.5	192	363	62	3060 211 135
400	249.5	224	413	74	3060 211 140
450	283.5	256	463	86	3060 211 145
500	309.5	288	513	98	3060 211 150
550	338.5	320	563	98	3060 211 155
600	370.5	352	613	110	3060 211 160
650	400.0	384	663	112	3060 211 165
700	430.0	416	713	134	3060 211 170

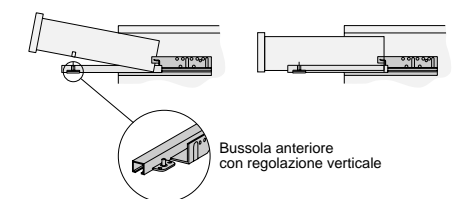
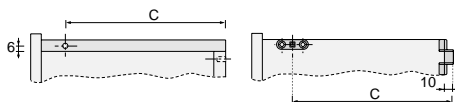
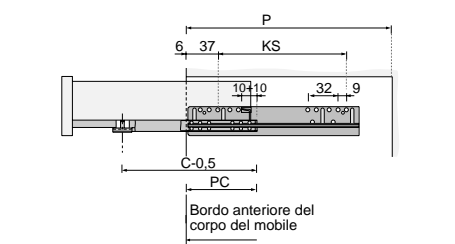
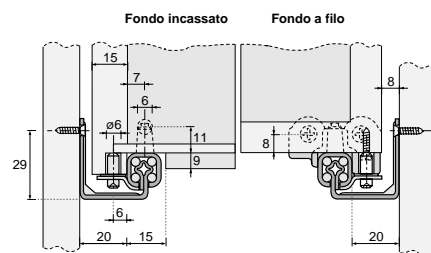

Guida quadro per cassette doppia estrazione

Acciaio
sistema di scorrimento su sfere
montaggio rapido a innesto
meccanismo completamente nascosto
portata max. 40 Kg

C = INTERASSE (aggancio - regolazione)
KS = INTERASSE FORI GUIDA
P = PROFONDITÀ MINIMA MOBILE
MG = MAGGIOR ESTRAZIONE

L	P	C	KS	MG	Codice
280-400	300-413	249.5	192	28	3060 211 327
350-500	360-513	309.5	256	29	3060 211 333
470-700	480-713	430.0	352	25	3060 211 345

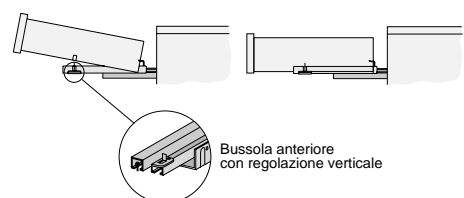
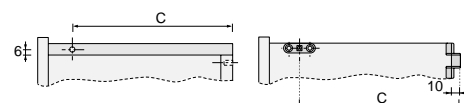
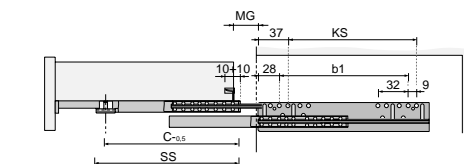
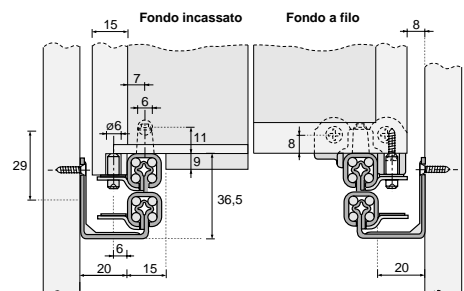

Guide a sfera per cassetti



Guida a sfera per cassetti

Acciaio zincato
Montaggio ad incasso da mm 17
Portata 10 kg



L1	L2	A	B	Codice
182	182	46	128	3011 005 019
246	246	70	96	3011 005 025
310	310	94	128	3011 005 031
374	374	94	160	3011 005 037

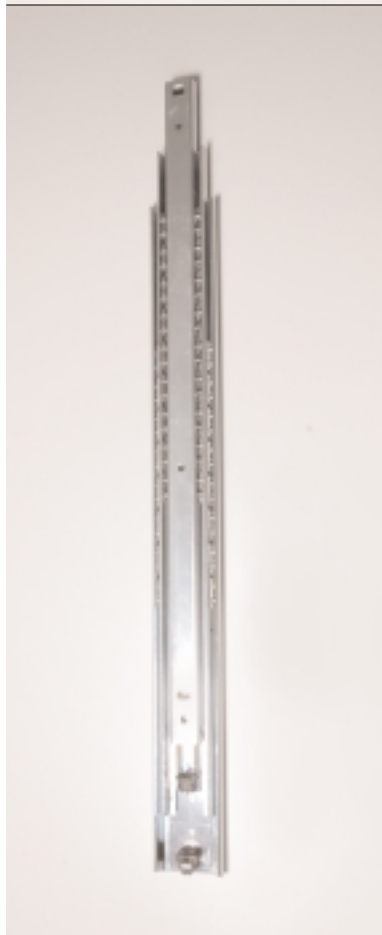
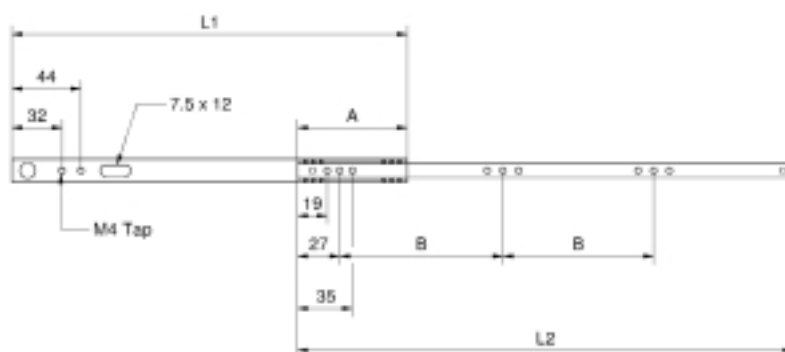

Guida a sfera per cassetti ad estrazione totale

Acciaio zincato
Montaggio laterale
Portata 70 kg

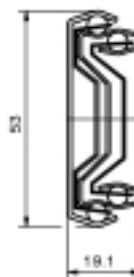

L	Codice
350	2517 305 335
400	2517 305 340
450	2517 305 345
500	2517 305 350
550	2517 305 355
600	2517 305 360

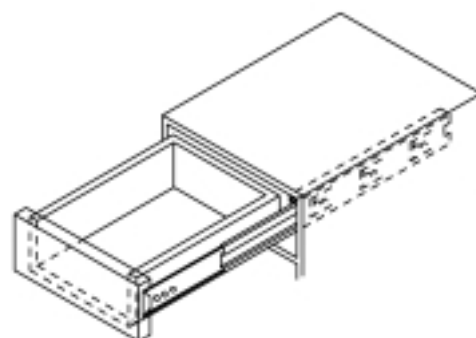

Spessori e sostegni per guide



A Spessori per montaggio guide
Nylon



B



C

Tipo	Misura	Codice
A	46 x 20 x 31H	1617 301 801
A	46 x 20 x 19H	1617 301 802
A	46 x 20 x 12,5H	1617 301 803
B	47 x 20 x 25H	1617 301 805
B	47 x 20 x 20H	1617 301 806
C	Ø 25 x 6,5H	1617 301 804

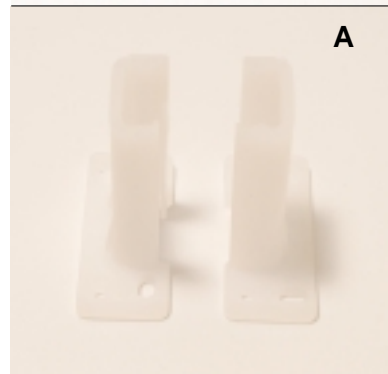
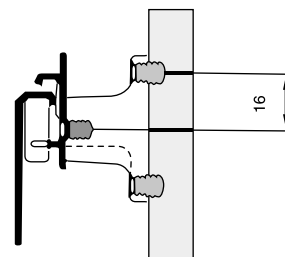

A

**Sostegno posteriore per
montaggio guide regolabili**
Nylon

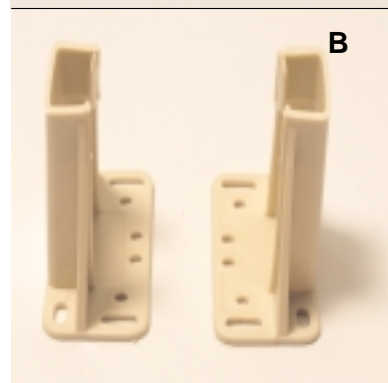

B

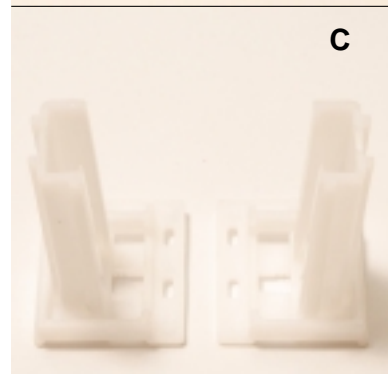

C

Tipo	Mano	Codice
A	Destro	2617 300 2DX
A	Sinistro	2617 300 2SX
B	Destro	2617 306 4DX
B	Sinistro	2617 306 4SX
C	Destro	2617 306 8DX
C	Sinistro	2617 306 8SX

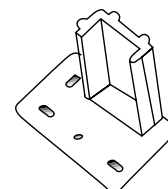
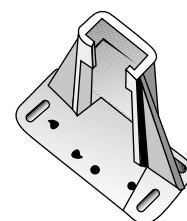
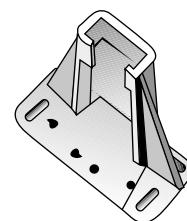

Cestelli estraibili



Cestello su guide

Acciaio verniciato
 montaggio guide sul fianco
 chiusura automatica negli ultimi 20 mm
 portata Kg. 25
 previsto come montaggio intermedio senza frontalino



L	P	H	Codice
414	500	160	5041 118 414
564	500	160	5041 118 564
864	500	160	5041 118 864

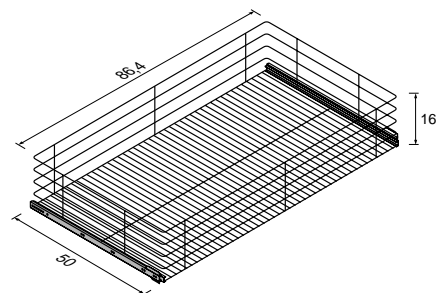
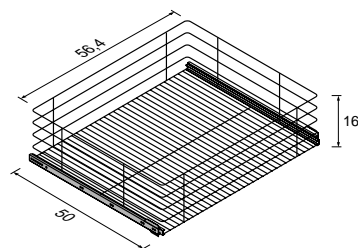
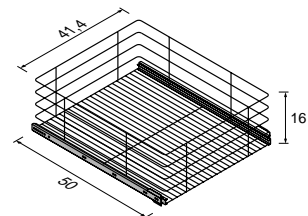

Cestello su guide

Acciaio verniciato
 montaggio guide sul fianco
 chiusura automatica negli ultimi 20 mm
 portata Kg. 25
 con angolare per fissaggio frontale cassetto

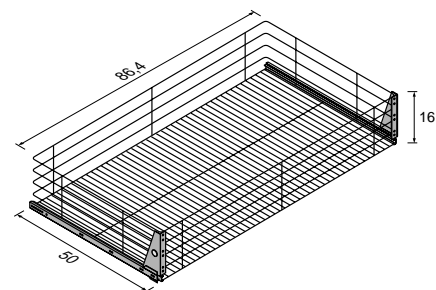
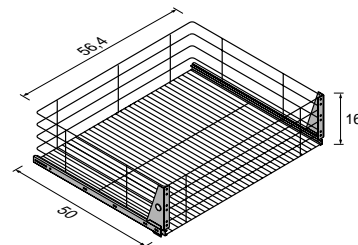
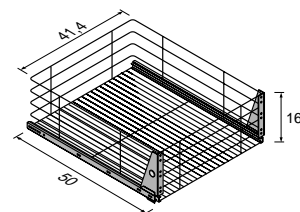

L	P	H	Codice
414	500	160	5041 115 414
564	500	160	5041 115 564
864	500	160	5041 115 864

Cestelli estraibili



Cestello piccolo su guide

Acciaio verniciato
 montaggio guide sul fondo
 chiusura automatica negli ultimi 20 mm
 portata Kg. 25
 con angolare per fissaggio frontale cassetto

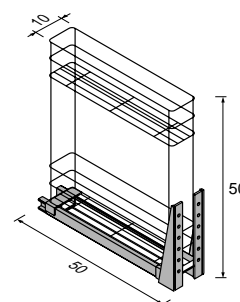

L	P	H	Codice
100	280	500	5041 003 100
100	500	500	5041 003 200



Cestello su guide per bottiglie

Acciaio verniciato
 montaggio guide sul fondo
 chiusura automatica negli ultimi 20 mm
 portata Kg. 25
 con angolare per fissaggio frontale cassetto

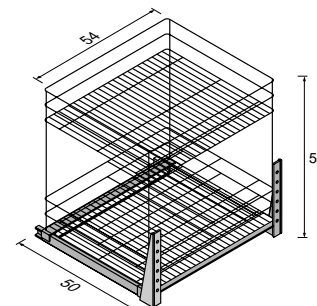
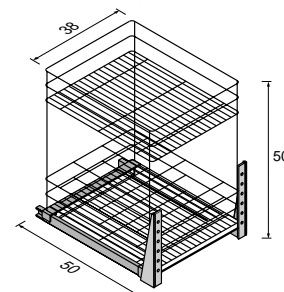
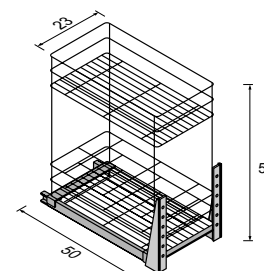

L	P	H	Codice
230	500	500	5041 003 230
380	500	500	5041 003 380
540	500	500	5041 003 540

Cestelli estraibili



Cestello con serratura

Acciaio verniciato
 montaggio guide sul fondo
 il cestello viene utilizzato all'interno di basi con ante

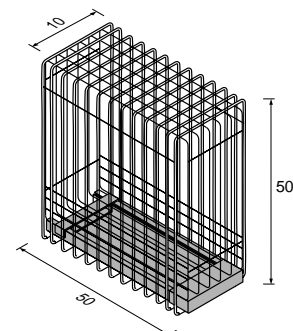

L	P	H	Codice
230	480	500	5041 003 383



Cestello girevole a mezzaluna

Acciaio verniciato
 montaggio sul fianco mobile
 apertura con ante o manuale

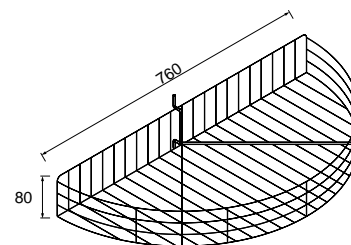

Misura	Versione	Codice
760 x 360 x 80	1 piano	5041 003 541
760 x 360 x 80	2 piani	5041 003 542

Supporti girevoli

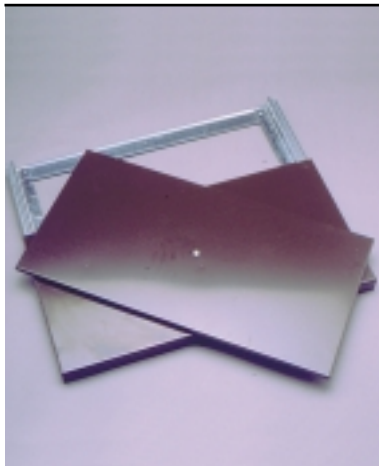

Guida portatelevisore ad estrazione totale

Acciaio verniciato
portata dinamica Kg. 60 statica Kg. 80
piano girevole di 360°

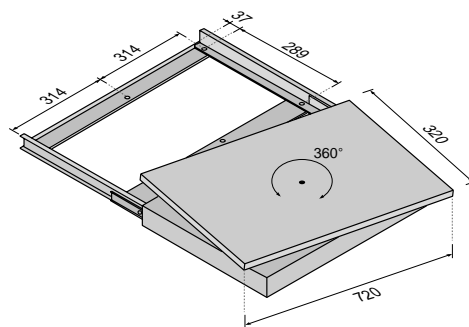

Finitura	Codice
Bianca	3047 015 015
Marrone	3047 015 016



Guida portatelevisore ad estrazione totale

Acciaio verniciato
portata dinamica Kg. 60 statica Kg. 80
piano girevole di 180°

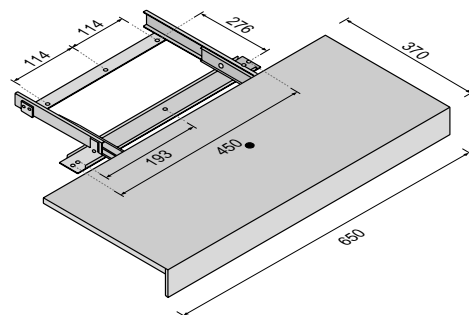

Finitura	Codice
Marrone	3047 015 012
Bianca	3047 015 010



Piastra girevole a 360°

Acciaio zincato montata su sfere

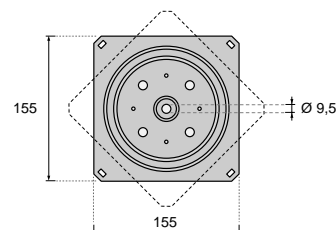
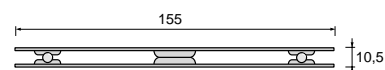

Codice
3047 002 015

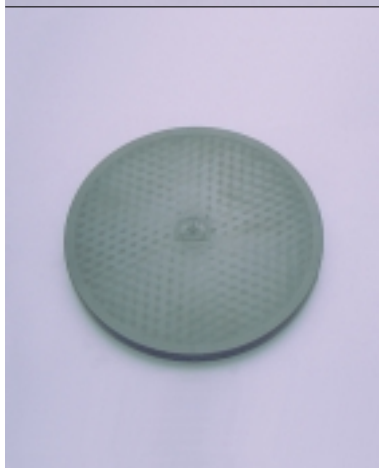

Piastra girevole a 360°

Acciaio e plastica montata su sfere

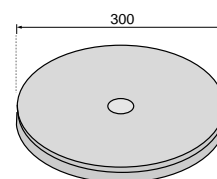

Spessore = mm 15

Codice
3047 010 001

